

WQ01方型单轨 Single square guide rails



产品特性 Product features

- 方型铝合金单轨
 - 硬质氧化滑动表面
 - 免维护的线性滑动导轨
 - 免润滑、抗污
 - 重量轻和静音
 - 自由设计安装宽度
- Square single guide rails made of aluminum
 - Hard anodized the sliding surface
 - Maintenance-free linear sliding guide rails
 - Lubrication-free and dirt-resistant
 - Light weight and quiet
 - Variable width can be fitted

标准规格 Standard specifications

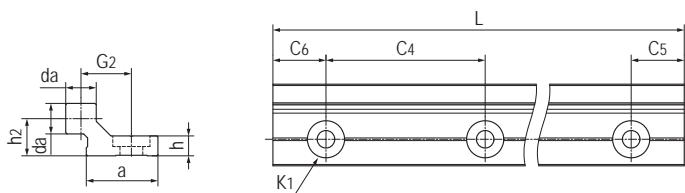

产品编码 Part No.:

WQ01-06-0000-NH

- 空白Blank: 带安装孔 With mounting holes
- NH: 无安装孔 No mounting holes
- 长度 Length
- 尺寸 Size

产品编码 Part No.	da _{0.1} [mm]	G ₂ [mm]	h [mm]	h ₂ [mm]	a [mm]	C ₄ [mm]	C ₅ =C ₆ [mm]		K ₁ [mm]	L max. [mm]	重量 Weight [kg/m]
							min.	max.			
WQ01-06-0000	5	10.5	4	7.5	14	60	20	49.5	M4	3000	0.23
WQ01-10-0000	7.5	17	5.5	11	25	120	20	79.5	M6	3000	0.54
WQ01-16-0000	11.5	19	7.5	14	27	120	20	79.5	M8	3000	0.94
WQ01-20-0000	15	21	9.5	20	27	120	20	79.5	M8	3000	1.41

产品编码 Part No.	da _{0.1} [mm]	G ₂ [mm]	h [mm]	h ₂ [mm]	a [mm]	C ₄ [mm]	C ₅ =C ₆ [mm]		K ₁ [mm]	L max. [mm]	重量 Weight [kg/m]
							min.	max.			
WQ01-06-0000-NH	5	10.5	4	7.5	14	-	-	-	-	3000	0.23
WQ01-10-0000-NH	7.5	17	5.5	11	25	-	-	-	-	3000	0.54
WQ01-16-0000-NH	11.5	19	7.5	14	27	-	-	-	-	3000	0.94
WQ01-20-0000-NH	15	21	9.5	20	27	-	-	-	-	3000	1.41

WQU01方型导轨滑块 Square guide rail blocks



产品特性 Product features

- 安装LIN-11Q方型滑动膜
 - 自润滑、免维护
 - 用于WQ系列方型导轨
 - 抗灰尘、无噪音
- Fitted LIN-11Q square liners
 - Maintenance-free, dry-running
 - For WQ square guide rails
 - Resistant dust and quiet

标准规格 Standard specifications

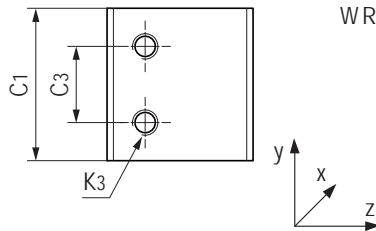
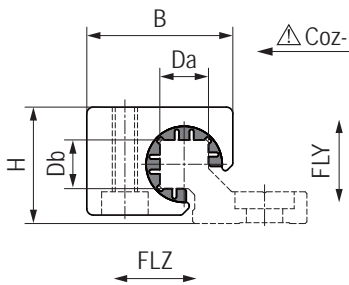

产品编码 Part No.:

WRU01-10-FLY-MN2

材料 Material:MN2
空白 Blank:EPB13

FLY:浮动方向 Floating direction Y
FLZ:浮动方向 Floating direction Z
空白 Blank:标准 Standard

尺寸 Size

产品编码 Part No.	Da ^{+0.102} _{-0.032} [mm]	Db ^{+0.102} _{-0.032} [mm]	B [mm]	C ₁ [mm]	C ₃ [mm]	K ₃ [mm]	H [mm]	静态载荷 Static load			重量 Weight [kg/m]
								Coy [N]	Coz+ [N]	Coz- [N]	
WQU01-06	5	5	18	19	4.5	M3	14	420	420	140	8
WQU01-10	7.5	7.5	26	29	6.5	M5	20	1200	1200	250	21
WQU01-16	11.5	11.5	34.5	36	9	M6	27	2100	2100	400	51
WQU01-20	15	15	42.5	45	9	M6	36	3200	3200	500	104
WQU01-06-FLY	5	5.5	18	19	4.5	M3	14	420	420	140	8
WQU01-10-FLY	7.5	8.2	26	29	6.5	M5	20	1200	1200	250	21
WQU01-16-FLY	11.5	12.5	34.5	36	9	M6	27	2100	2100	400	51
WQU01-20-FLY	15	16	42.5	45	9	M6	36	3200	3200	500	104
WQU01-06-FLZ	5.5	5	18	19	4.5	M3	14	420	420	140	8
WQU01-10-FLZ	8.2	7.5	26	29	6.5	M5	20	1200	1200	250	21
WQU01-16-FLZ	12.5	11.5	34.5	36	9	M6	27	2100	2100	400	51
WQU01-20-FLZ	16	15	42.5	45	9	M6	36	3200	3200	500	104

WQ02方型双轨 Double square guide rails



产品特性 Product features

- 方型铝合金双轨
 - 硬质氧化滑动表面
 - 免维护的线性滑动导轨
 - 免润滑、抗污
 - 重量轻和静音
 - 标准安装宽度
- Square double guide rails made of aluminum
 - Hard anodized the sliding surface
 - Maintenance-free linear sliding guide rails
 - Lubrication-free and dirt-resistant
 - Light weight and quiet
 - Standard fitting width

标准规格 Standard specifications

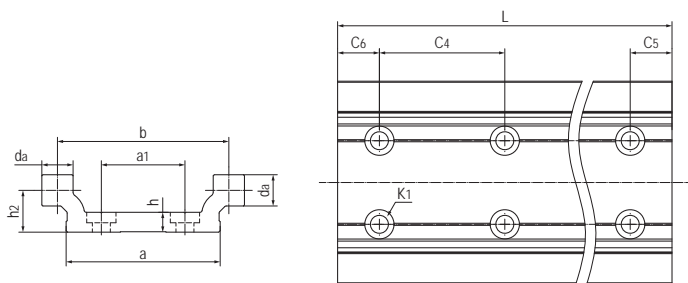

产品编码 Part No.:

WQ02-06-30-0000-NH

空白Blank: 带安装孔 With mounting holes
NH: 无安装孔 No mounting holes
长度 Length
宽度 Width
尺寸 Size

产品编码 Part No.	$d_{a0.1}$ [mm]	b [mm]	a [mm]	a_1 [mm]	h [mm]	h_2 [mm]	C_4 [mm]	$C_5=C_6$ [mm]		K_1 [mm]	L max. [mm]	重量 Weight [kg/m]
								min.	max.			
WQ02-06-30-0000	5	30	27	-	4	7.5	60	20	49.5	M5	3000	0.45
WQ02-10-40-0000	7.5	40	36	-	5.5	11	120	20	79.5	M6	3000	0.92
WQ02-16-60-0000	11.5	58	54	-	7.5	14	120	20	79.5	M8	3000	1.84
WQ02-20-80-0000	15	82	74	40	9.5	20	120	20	79.5	M8	3000	3.30

产品编码 Part No.	$d_{a0.1}$ [mm]	b [mm]	a [mm]	a_1 [mm]	h [mm]	h_2 [mm]	C_4 [mm]	$C_5=C_6$ [mm]		K_1 [mm]	L max. [mm]	重量 Weight [kg/m]
								min.	max.			
WQ02-06-30-0000-NH	5	30	27	-	4	7.5	-	-	-	-	3000	0.45
WQ02-10-40-0000-NH	7.5	40	36	-	5.5	11	-	-	-	-	3000	0.92
WQ02-16-60-0000-NH	11.5	58	54	-	7.5	14	-	-	-	-	3000	1.84
WQ02-20-80-0000-NH	15	82	74	-	9.5	20	-	-	-	-	3000	3.30

WQC01方型导轨滑台 Square guide rail carriages



产品特性 Product features

- 安装LIN-11Q方型滑动膜
 - 自润滑、免维护
 - 重量轻、快速装配
 - 用于WQ系列方型双轨
 - 抵抗灰尘、无噪音
- Fitted LIN-11Q square liners
 - Maintenance-free, dry-running
 - Fast assembly and light weight
 - For WQ double square guide rails
 - rails Resistant dust and quiet

标准规格 Standard specifications

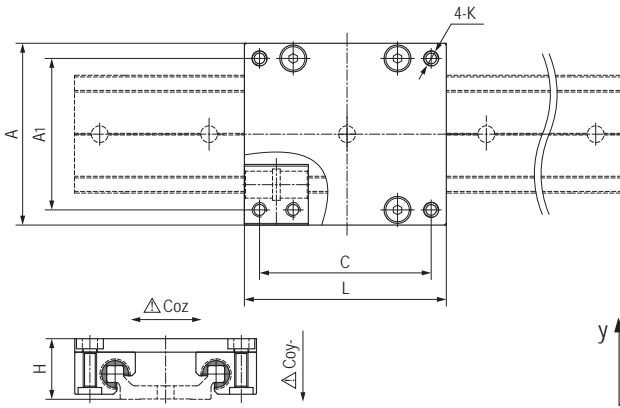

产品编码 Part No.:

WQC01-06-30-060-MN2

材料 Material:MN2

空白 Blank:EPB13

长度 Length

宽度 Width

尺寸 Size

产品编码 Part No.	L [mm]	C [mm]	A [mm]	A ₁ [mm]	H [mm]	K [mm]	静态载荷 Static load					重量 Weight [kg]
							Coy- [N]	Coz [N]	Mox [Nm]	Moy [Nm]	Mo _z [Nm]	
WQC01-06-30-060	60	51	54	45	18	M4	1680	840	25	34	34	0.07
WQC01-06-30-080	80	71	54	45	18	M4	1680	840	25	51	51	0.09
WQC01-06-30-100	100	91	54	45	18	M4	1680	840	25	68	68	0.12
WQC01-10-40-100	100	87	73	60	24	M6	4800	2400	96	170	170	0.21
WQC01-10-40-150	150	137	73	60	24	M6	4800	2400	96	290	290	0.32
WQC01-10-40-200	200	187	73	60	24	M6	4800	2400	96	410	410	0.42
WQC01-16-60-100	100	82	104	86	35	M8	8400	4200	240	270	270	0.41
WQC01-16-60-150	150	132	104	86	35	M8	8400	4200	240	480	480	0.61
WQC01-16-60-200	200	182	104	86	35	M8	8400	4200	240	690	690	0.80
WQC01-20-80-150	150	132	134	116	44	M8	12800	6400	525	670	670	0.99
WQC01-20-80-200	200	182	134	116	44	M8	12800	6400	525	990	990	1.33
WQC01-20-80-250	250	232	134	116	44	M8	12800	6400	525	1250	1250	1.66

WQC02方型导轨滑台 Square guide rail carriages



产品特性 Product features

- 安装LIN-11Q方型滑动膜
 - 自润滑、免维护
 - 整体式设计、低成本
 - 用于WQ系列方型双轨
 - 抵抗灰尘、无噪音
- Fitted LIN-11Q square liners
 - Maintenance-free, dry-running
 - Mono-design and low cost
 - For WQ double square guide rails
 - Resistant dust and quiet

标准规格 Standard specifications

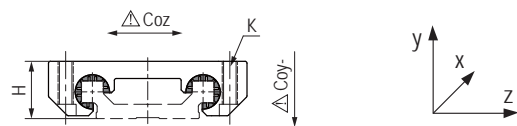
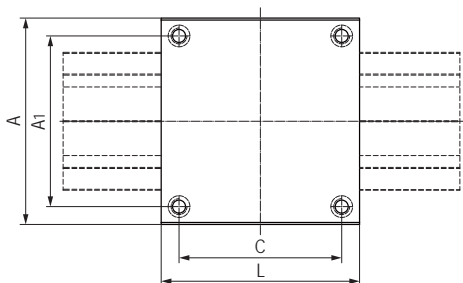

产品编码 Part No.:

WQC02-06-30-060-MN2

材料 Material:MN2
空白 Blank:EPB13
长度 Length
宽度 Width
尺寸 Size

产品编码 Part No.	L [mm]	C [mm]	A [mm]	A ₁ [mm]	H [mm]	K [mm]	静态载荷 Static load					重量 Weight [kg]
							Coy- [N]	Coz [N]	Mox [Nm]	Moy [Nm]	Moz [Nm]	
WQC02-06-30-060	60	51	54	45	16	M4	1680	840	25	34	34	0.07
WQC02-06-30-080	80	71	54	45	16	M4	1680	840	25	51	51	0.09
WQC02-06-30-100	100	91	54	45	16	M4	1680	840	25	68	68	0.12
WQC02-10-40-100	100	87	73	60	22	M6	4800	2400	96	170	170	0.21
WQC02-10-40-150	150	137	73	60	22	M6	4800	2400	96	290	290	0.32
WQC02-10-40-200	200	187	73	60	22	M6	4800	2400	96	410	410	0.42
WQC02-16-60-100	100	82	104	86	30	M8	8400	4200	240	270	270	0.40
WQC02-16-60-150	150	132	104	86	30	M8	8400	4200	240	480	480	0.62
WQC02-16-60-200	200	182	104	86	30	M8	8400	4200	240	690	690	0.87
WQC02-20-80-150	150	132	134	116	40	M8	12800	6400	525	670	670	1.00
WQC02-20-80-200	200	182	134	116	40	M8	12800	6400	525	990	990	1.41
WQC02-20-80-250	250	232	134	116	40	M8	12800	6400	525	1250	1250	1.77